

# Whisper Lift XL PRO Advanced TV Lift Manual

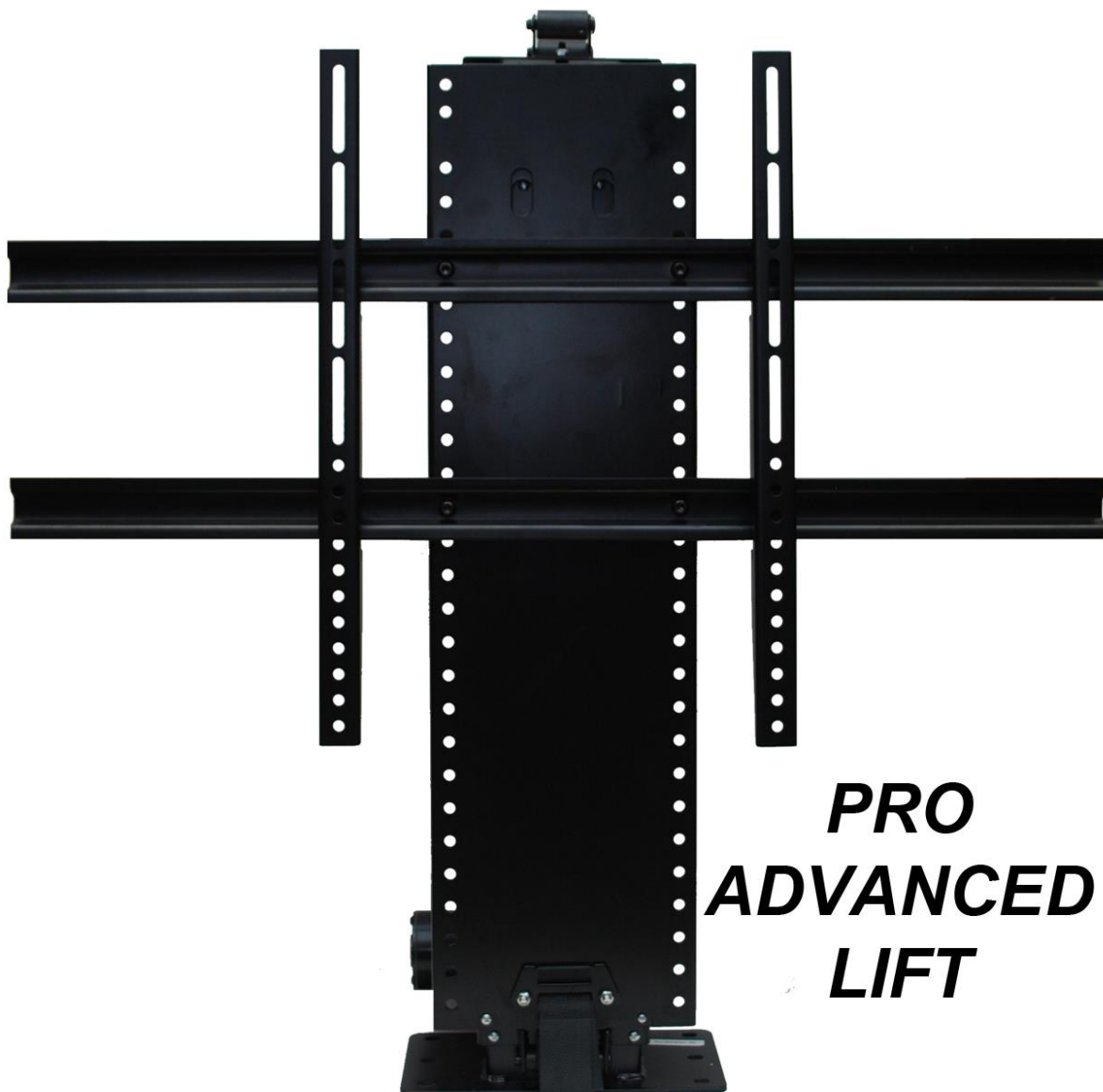

**PREMIUM  
ELECTRIC FIREPLACES  
& TV LIFTS**

Exceeding Expectations

## Table of Contents

Lift Features .....	3
<b>Dimensional Drawing</b> .....	4
<b>Safety</b> .....	5
IMPORTANT SAFETY and PRE-INSTALLATION INSTRUCTIONS.....	5
<b>Lift Components &amp; TV Installation Hardware</b> .....	6
Components .....	6
Hardware.....	6
Tools .....	6
<b>Assembling Your Whisper Lift XL PRO Advanced TV Lift</b> .....	7
Adjusting Lift Mounting Supports.....	7
Fasten Lift To Cabinet .....	8
Hookup Lift Control Box and Power Supply .....	9
<b>Operating the Whisper Lift XL PRO Advanced TV Lift</b> .....	13
Operating the Wireless Remote .....	13
Operating the Wired Remote .....	13
<b>Mounting and Installing the TV</b> .....	14
Installing Crossbrackets on TV Lift.....	14
Attaching TV Mounting Brackets to Flat Panel TV .....	16
Installing TV on Lift .....	18
Installing Locking Brackets on Whisper Lift XL PRO Advanced TV Lift.....	19
Setting Adjustable Roller Height .....	21
<b>Whisper Lift XL PRO Advanced TV Lift Features</b> .....	22
Initialize the Whisper Lift XL PRO Lift.....	22
Pairing Universal IR Remote with Whisper Lift XL PRO Advanced .....	23
Setting Lift Height .....	24
Setting Lift Height Memory Button (Middle Button) on Wireless Remote .....	24
<b>Optional Accessories</b> .....	25
Assembling Component Shelf (optional).....	25
IR Repeater Kit (optional) .....	31
<b>Technical Support</b> .....	31
<b>Warranty</b> .....	31

## About Your Touchstone Whisper Lift XL PRO Advanced TV Lift

Congratulations on the purchase of your Touchstone Whisper Lift XL PRO Advanced TV Lift. Touchstone Home Products takes pride in the quality craftsmanship and smooth functionality of our TV lift mechanism. Please take a few minutes to learn about the features of your TV lift to ensure you get the optimum use and performance from your new purchase.

### Lift Features

- Durable steel construction with 24v motor for smooth, quiet and reliable operation
- Lift cycle fully raises or lowers in approximately 50 seconds.
- Universal quick connect installation takes just minutes. Includes hardware kit with bolts for mounting TV brackets to TV.
- 3-way adjustable mounting system to ensure that the Whisper Lift XL PRO Advanced TV Lift is compatible with almost all flat panel TVs in the market today.
- Modular design – all components can be easily replaced in just minutes
- Optional component shelf
- 5 year worry-free warranty

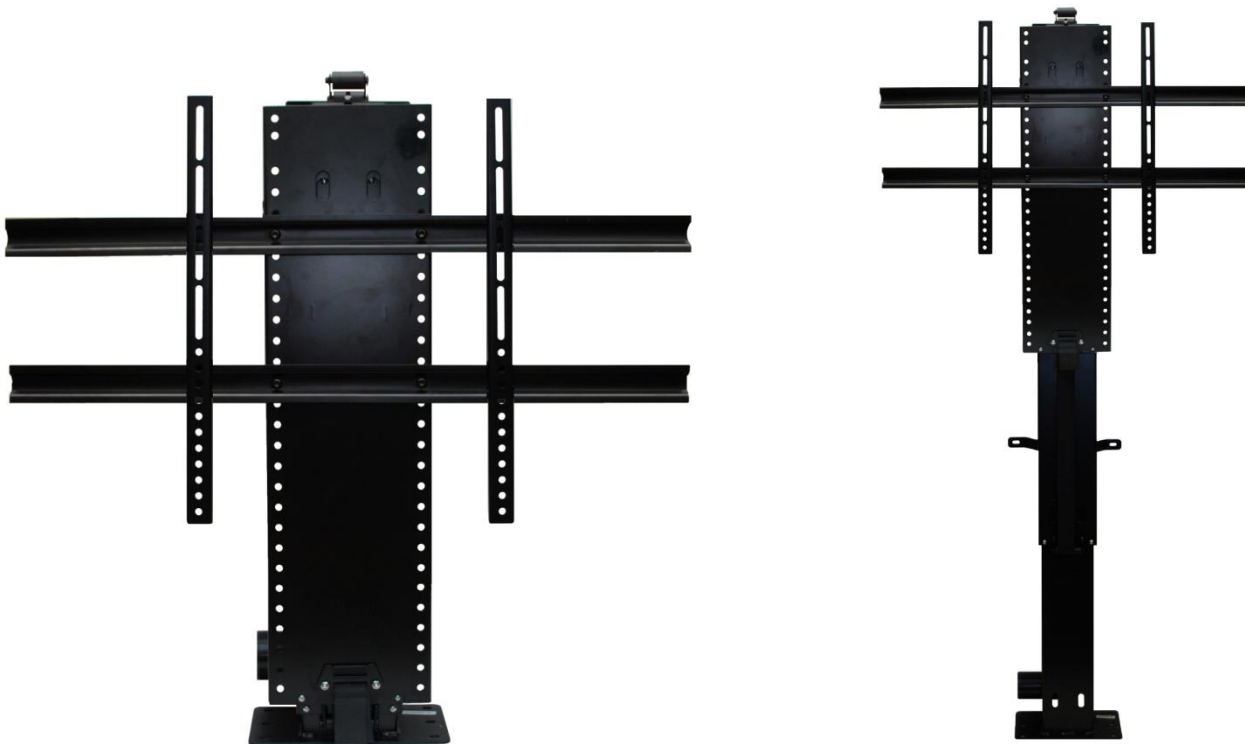

## Dimensional Drawing

**ts touchstone** **PREMIUM ELECTRIC FIREPLACES & TV LIFTS** Exceeding Expectations

**Whisper Lift PRO XL Dimensions**  
PN: 23601

**23601 - Whisper Lift PRO XL Features:**

- Roller system for hinged lids
  - > 47 1/2" high without roller lowered, 96 1/2" without roller raised
- Flat top for connected lids
  - > 46 1/4" high without roller lowered, 95 1/4" without roller raised
- 200lb weight capacity
- Mounts to the floor and back
- Universal TV mounting brackets included
- Minimum cabinet TV cavity dimensions:
  - height: 49"
  - depth: 7" plus TV depth
  - width: TV width + 1"
- 49" of stroke (works with TVs up to 48 1/2" tall w/o stand)
- Can be used in drop down applications

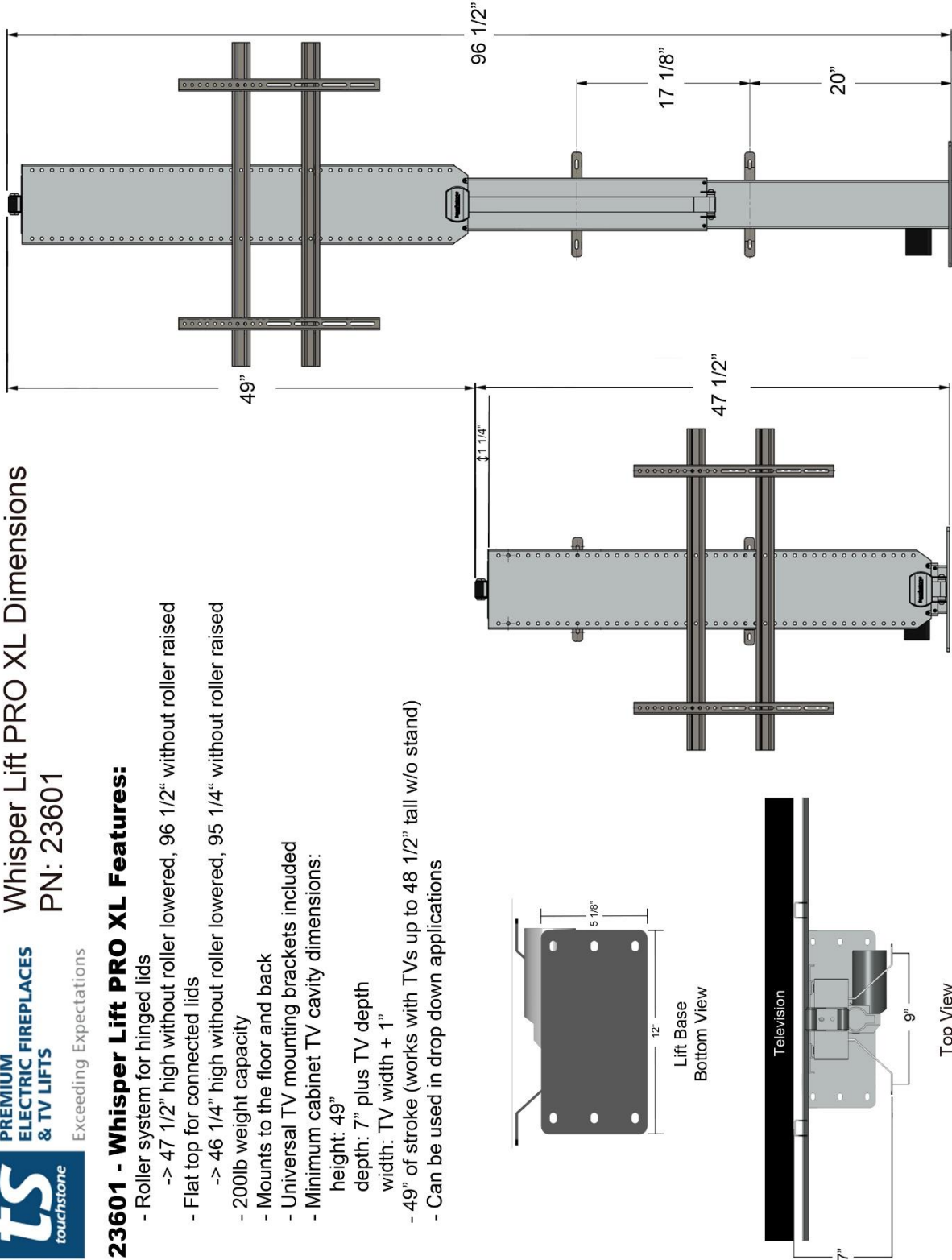

## Safety

*Mounting your flat screen TV to the Touchstone Whisper Lift XL PRO Advanced TV Lift is fast and easy. Operating your lift is very straightforward. However, to avoid the risk of personal injury and to ensure optimum performance of your TV lift mechanism, please pay particular attention to the warnings and safety notices throughout this manual.*

### IMPORTANT SAFETY and PRE-INSTALLATION INSTRUCTIONS

1. Please adhere to the proper installation procedure as detailed in the installation instructions.
2. Safety precaution measures must be practiced at all times during installation of this product.
3. The entire installation instructions should be fully read and understood before beginning installation.
4. At least two people should be available to lift the TV onto the lift mechanism. Please take care when handling your flat screen TV, as injury and damage can result from dropping or mishandling of the TV.
5. Plasma screen TVs should remain upright at all times. Never place the screen face down on the floor. This could cause damage to the TV.
6. **The stand on your flat screen TV is removable!** Please remove the stand prior to installing the TV on the lift mechanism. Consult your TV's owner's manual for instructions for removing the stand.
7. Carefully measure all dimensions of your LCD, PLASMA, or LED TV before proceeding. Then consult the **Mounting and Installing the TV** section of this manual for maximum TV size.

**IMPORTANT!:** After installing your TV, you may find there is room in the bottom of the cabinet to install a small cable/satellite TV box. Carefully inspect the space between the bottom of the TV and the bottom of the cabinet to see if your component will fit in the bottom of the cabinet. Consult the **Mounting and Installing the TV** section of this manual for more information.

8. All cords connecting components to the TV should be a minimum of 108" (9 feet) in length when installing components inside of a cabinet or a minimum of 180" (15 feet) in length when installing components outside of cabinet (length of cable will depend on placement of your component).
9. **WARNING!:** TV lift mechanism contains moving parts. Please keep hands, arms, and fingers away from the lift and cabinet lid opening when the lift is in motion. Cables should be wire-tied or secured neatly so lift does not contact them during operation. Also, keep all components away from the lift mechanism.
10. **WARNING!:** The Whisper Lift XL PRO has a max height of 96.5" from the base of the lift to the top of the roller assembly. We recommend that there is at least 98" of clearance between base of the lift and any item above the top of the lift when fully extended. Touchstone Home Products is not responsible for damage to items placed above the TV and TV lift, or items attached to the lift.

Contact Touchstone Customer Service at 1-800-215-1990 with any questions regarding the operation of your Whisper Lift XL PRO Advanced TV Lift. We are also available on the web at [www.touchstonehomeproducts.com](http://www.touchstonehomeproducts.com)

## Lift Components & TV Installation Hardware

### Components

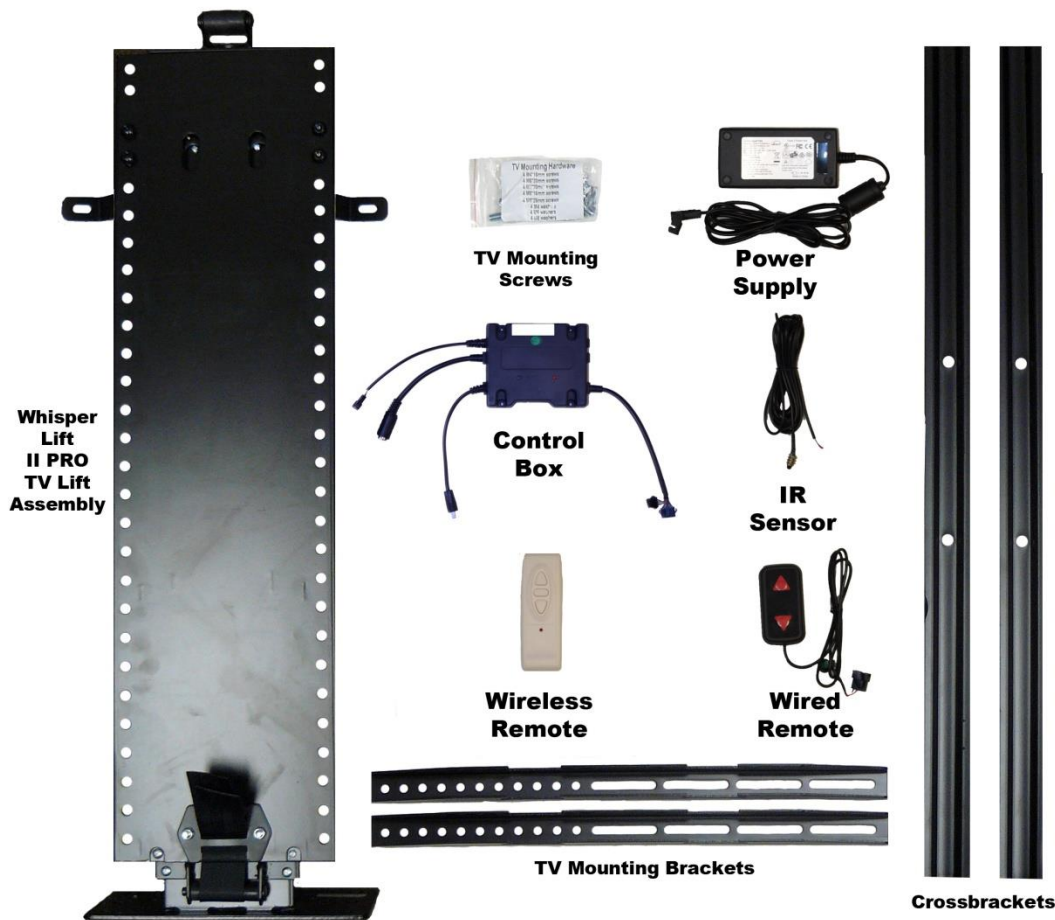

### Hardware

#### - TV Mounting Screws

-> Please consult your TV manufacturer for the size and length of the mounting screw for your TV. Included is a basic set of mounting screws that accommodates most LCD/Plasma TVs. Depending on your television, the screws included in the kit may not fit your television. If that is the case, these screws can be purchased at most hardware/home improvement stores.

### Tools

In order to assemble the Whisper Lift XL PRO Advanced TV Lift, you will need the following tools:

- Philips-head screwdriver
- size 4 metric hex wrench
- size 5 metric hex wrench
- adjustable wrench or size 4 and size 5 metric socket wrench



## Assembling Your Whisper Lift XL PRO Advanced TV Lift

### Adjusting Lift Mounting Supports

***Tools Needed:***

- adjustable wrench

***Instructions:***

The Whisper Lift XL PRO Advanced TV Lift ships with 4 mounting brackets pre-installed on the back of the lift as shown in the picture below:



Typically, these brackets do not require any adjusting by the customer. Should you need to adjust these brackets to level the lift, loose the nuts holding the bracket to the lift and move the bracket accordingly.

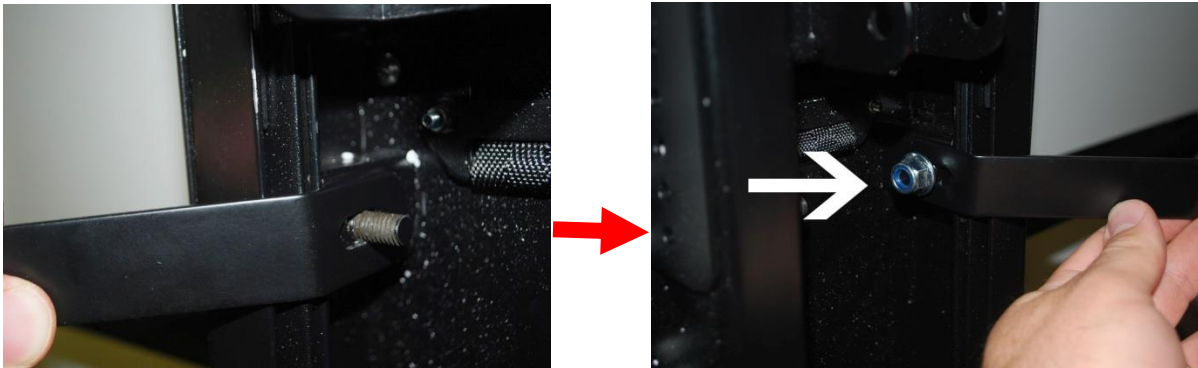

Once adjusted, the lift is ready for installation.

## Fasten Lift To Cabinet

### *Parts Needed:*

The Whisper Lift XL PRO Advanced TV Lift has 10 mount points (4 on the back of the lift and 6 on the floor). Use the rear 2 mount points and at least 4 of the 6 floor mount points to mount the lift in your cabinet.

### *Instructions:*

1. Open cabinet lid and place lift in cabinet.
2. Align lift with mounting holes on floor and back wall of cabinet (fig A)
3. Using the wood screws (not provided), attach the lift to the cabinet, making sure the screws are tight and secure the lift.





## Hookup Lift Control Box and Power Supply

### *Parts Needed During This Step:*

- Control box
- Power supply
- Wired remote

### *Instructions:*

#### Control Box Connections

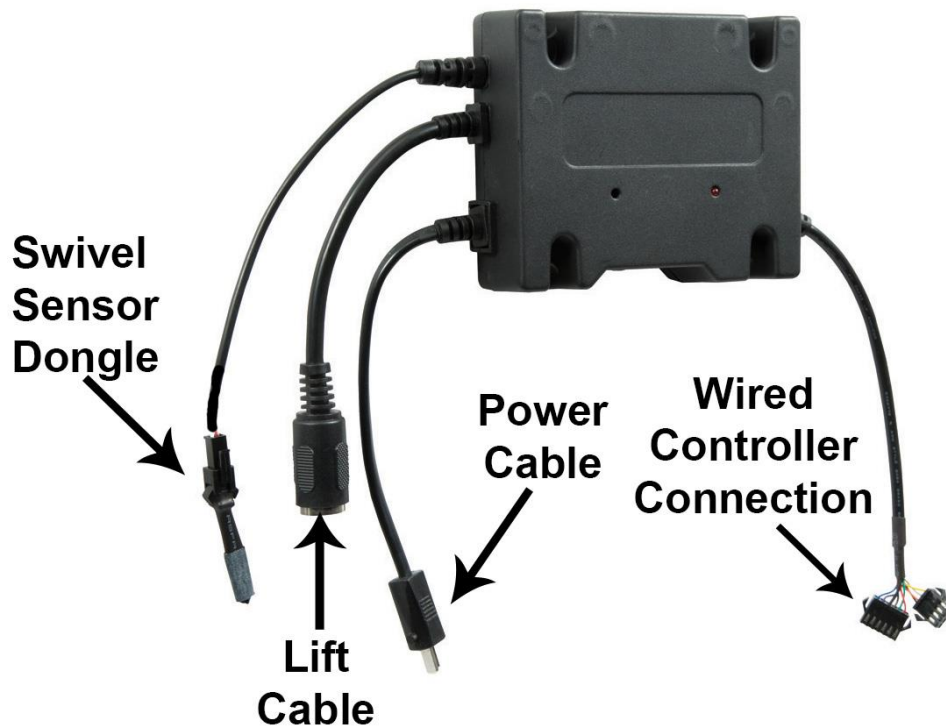

#### Control Box Connections (side view)



A = 12v Trigger Port

B = IR Sensor Port

**\*\*The Swivel Lift cable has a dongle inserted in the connector at the end of the Swivel Lift Cable. DO NOT REMOVE THIS DONGLE! The lift will not operate without the dongle installed.**

## Hookup Control Box and Power Supply – cont.

### Installing Control Box

1. Attach the control box to your cabinet using the 4 screws provided.

### Attach Lift Cable into Control Box

1. Plug the lift motor cable into the Lift Cable Connection on the control box.



### Install Wired Remote

1. Connect the cable from the wired remote to the Handset Cable Connection cable on the control box.

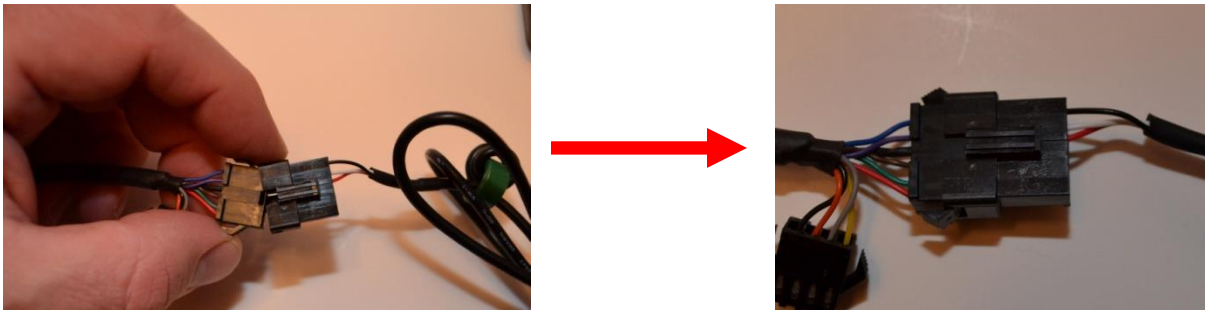

2. Remove the velcro from the back of the wired remote and mount handset on wall of cabinet.

## Hookup Control Box and Power Supply - cont

### Install Power Cable

1. To connect power cable from power supply to power cable on control box, line up the connections on each cable so they match and slide the plug on the control box end into the connection on the power supply.

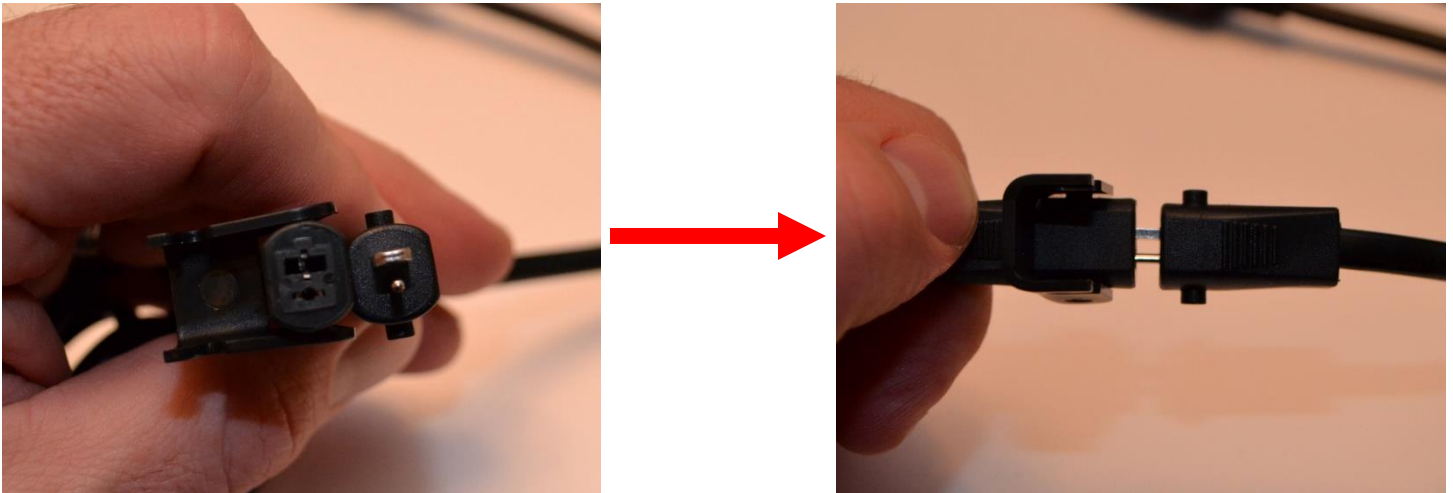

2. Close clip to secure power supply cable in place.

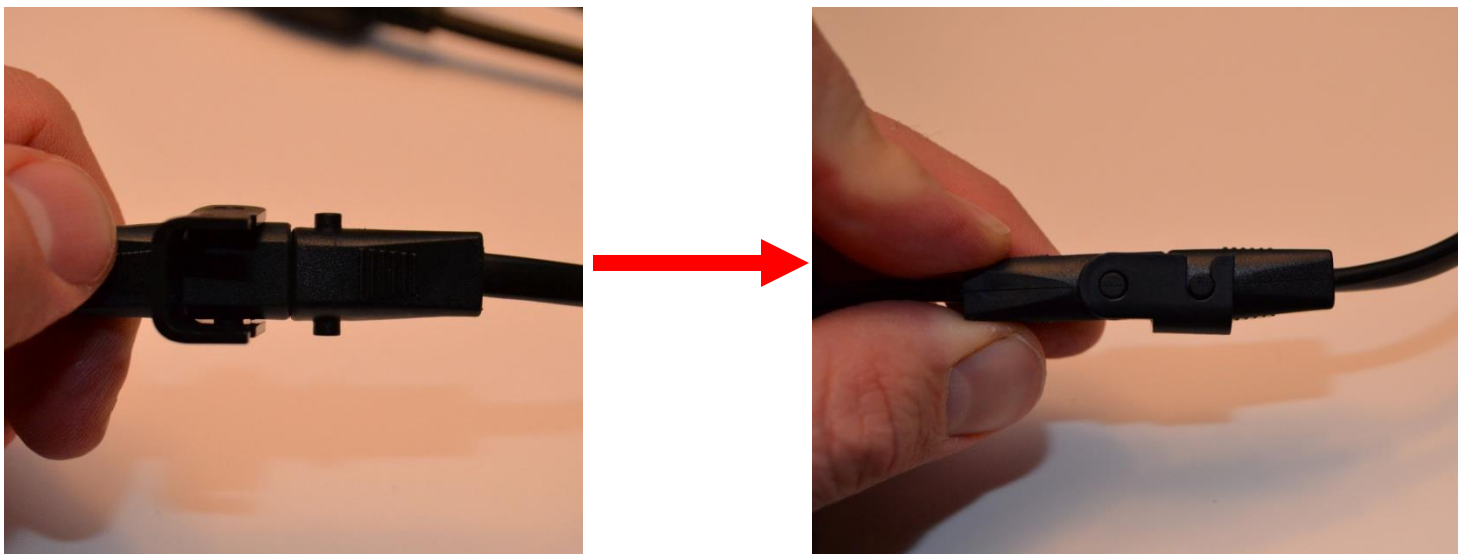

3. Attach power supply cable to power supply.

4. Remove velcro from back of power supply and install power supply in cabinet.

## Hookup Control Box and Power Supply - cont

### Install IR Sensor

If you plan to use the Whisper Lift XL PRO Advanced TV Lift with an existing IR remote control, attach the IR sensor to port B on the side of the control box.



IR Sensor Cable

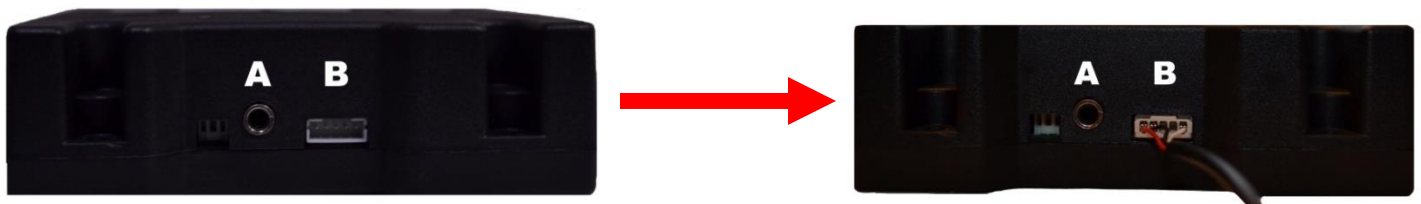

After installing the IR Sensor cable, install the IR sensor cable into your cabinet. Please refer to p.23 for instructions on pairing the Whisper Lift XL PRO Advanced TV Lift with your existing IR remote control.

### Install 12v Trigger Cable (optional)

The Whisper Lift XL PRO Advanced TV Lift comes equipped with a 12v trigger port (port A) for connection to automated systems. A male 3.5mm mono cable is required for this connection. A constant 12v 200mA setting is required from your 3<sup>rd</sup> party control system to control the lift via the 12v trigger connection.

*\*\*12v trigger cable not included.*

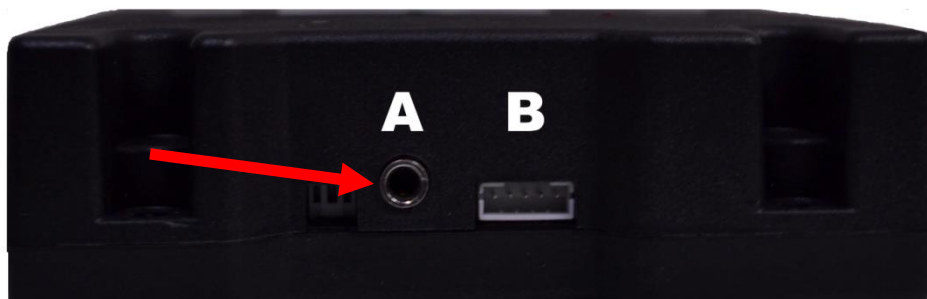

## Operating the Whisper Lift XL PRO Advanced TV Lift

### Operating the Wireless Remote

The remote control for your Touchstone Whisper Lift XL PRO Advanced TV Lift is controlled via radio frequency. You do not need to point the remote control directly at the cabinet to operate the lift.

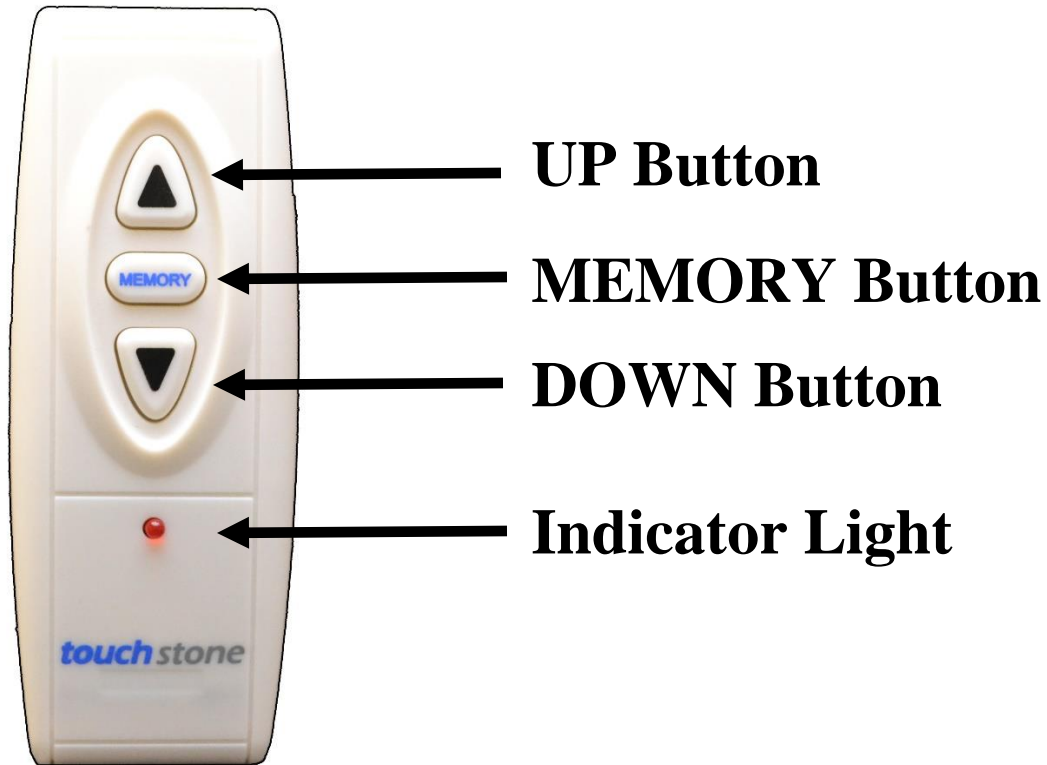

\*\* Lift Height Memory button will only function when button has been programmed by user. To program this button, please refer to the instructions on p. 24 of this manual.

### Operating the Wired Remote

A wired control is included with your Touchstone Whisper Lift XL PRO Advanced TV Lift, which can be mounted inside of the cabinet and control the lift should you misplace the wireless remote control.



When installing the wired remote in the cabinet, the DOWN arrow points toward the wire and the UP arrow points away from the wire.

## Mounting and Installing the TV

**IMPORTANT:** Prior to installing the TV onto the lift, please ensure the following:

- If you have not done so already, remove the stand from your flat screen TV.
- TV weight needs to be under 100lbs.
- TV has VESA compliant mounting pattern.

**NOTE:** It is recommended to raise the lift to mount and crossbrackets and TV on the lift.

### Installing Crossbrackets on TV Lift

**Tools Needed:**

- adjustable wrench
- size 5 metric hex wrench

**Parts Needed During This Step:**

- TV Lift
- 2 cross brackets
- 4 large hex screws- size 5
- 4 large lock nuts

**Instructions:**

1. Gather the 2 long crossbrackets, 4 large hex screws, and 4 large lock nuts.
2. Mount the top crossbracket in the 6<sup>th</sup> set of holes from the top of the lift. Use 2 large hex screws and 2 lock nuts to secure the crossbracket to the lift.





## Installing Crossbrackets on TV Lift – cont

3. Mount the bottom crossbracket 7 holes down from the top crossbracket. Use the remaining 2 large hex screws and 2 lock nuts to secure the crossbracket to the lift.

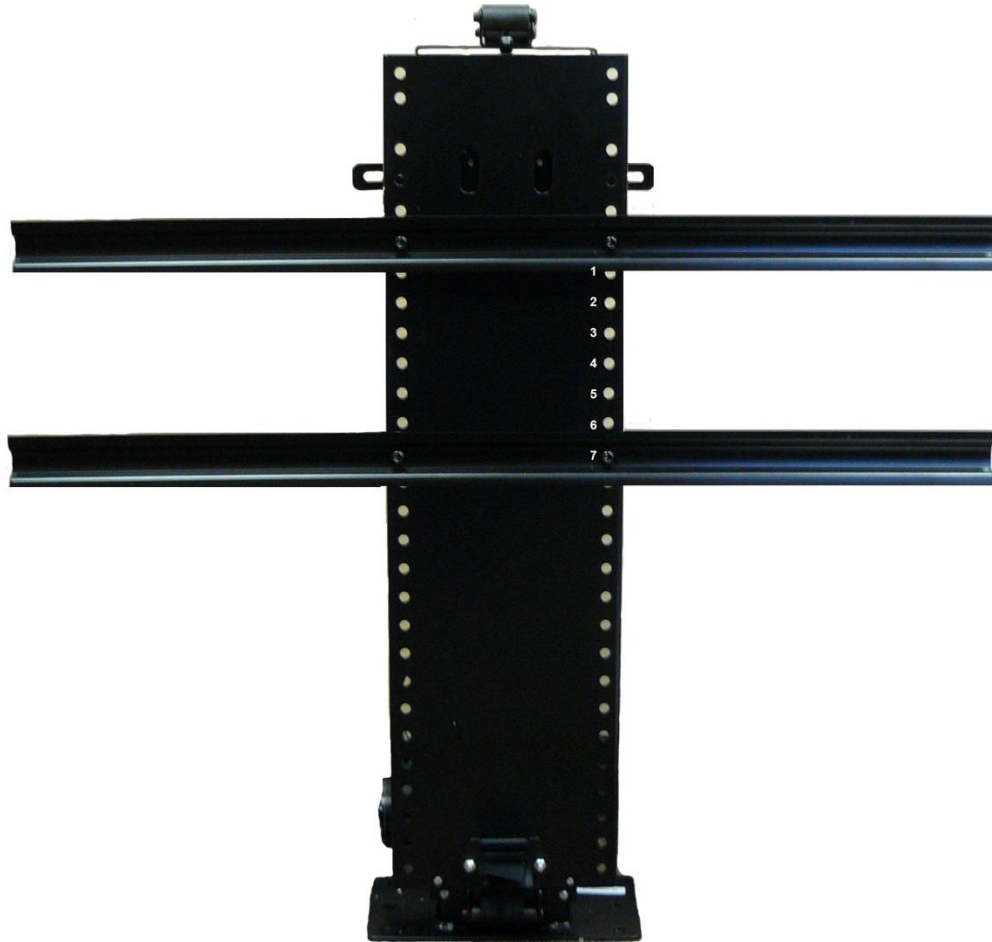

\*\*NOTE: Make sure that the brackets are secured tightly to the lift prior to operation.

## Attaching TV Mounting Brackets to Flat Panel TV

### *Tools Required*

- Phillips head screwdriver

### *Parts Required*

- TV mounting brackets
- TV mounting screws

\*\*\*Note: Touchstone Home Products includes a screw pack containing some of the most popular sizes of mounting screws, used by most TVs on the market. Due to the amount of TVs in the marketplace and no standard for mounting screw size, Touchstone Home Products cannot guarantee that the screws required for your TV are included in the screw pack. Please consult your TV manufacturer for the size of the mounting holes in the back of your TV and use the appropriate size screws. Touchstone Home Products assumes no liability for damage to a TV.

### *Instructions*

1. Remove stand from TV. Consult TV manual for instructions on removing the stand from the TV.
2. Locate the TV mounting brackets. They are pictured below.



**TV Mounting  
Brackets**

## Attaching TV Mounting Brackets to Flat Panel TV- cont

3. Align TV mounting brackets so that brackets are centered on the back of the TV. Place the TV mounting bracket so that the slotted holes are toward the top of the TV, while the round holes are toward the bottom of the TV.

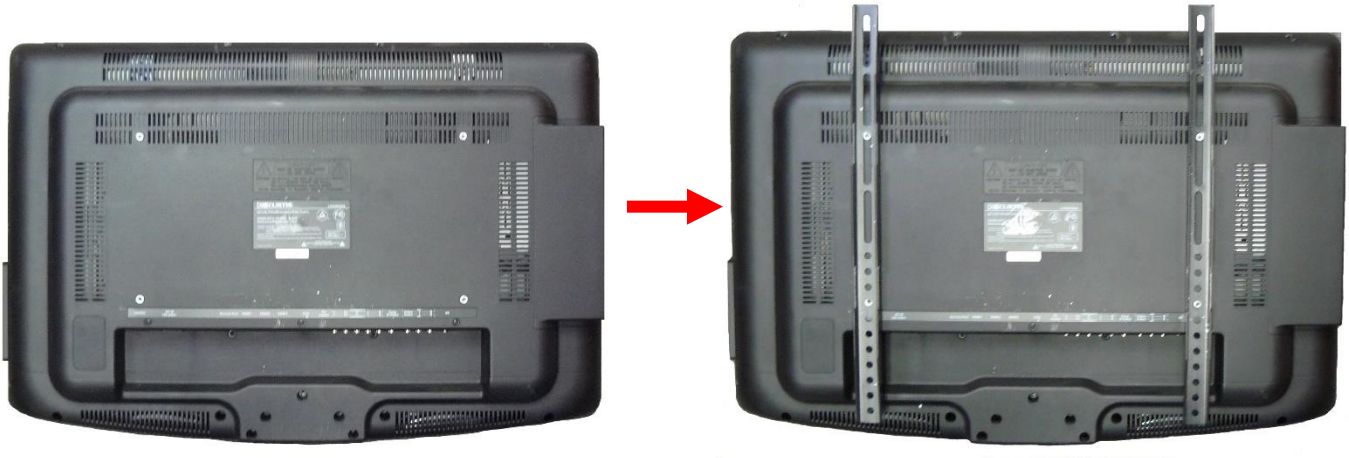

4. Attach TV mounting brackets to back of TV. Consult your TV owner's manual for the proper size mounting screw.



## Installing TV on Lift

1. Using the internal wired control, move the lift to the up position. The UP button is the button opposite of the cable side of the wired remote.



2. Hang TV on top crossbracket.



3 With TV hanging on top crossbracket, slightly raise the TV (a) and push it back toward the lift (b) so that the bottom crossbracket is centered between the bottom set of hooks on the back of the TV mounting brackets.



4. Move the TV down slightly to fully attach TV to crossbrackets. The TV will hang on the top crossbracket and the upper set of hooks on the bottom of the TV mounting brackets will lock the TV in place from moving while on the lift.

**\*\*Please Note:** The top of the TV should be lower than the roller assembly on top of the lift. This will insure that the roller is the first thing to come in contact with the lid when the lift goes up.

## Installing Locking Brackets on Whisper Lift XL PRO Advanced TV Lift

### *Tools Needed:*

- Philips-head screwdriver

### *Instructions*

1. Locate the bag with the Locking Bracket Kit included with your lift. In this bag, there will be 2 brackets and 2 philips-head screws.



2. Install the screw in each bracket so that the end opposite of the head of the screw is just slightly through the bracket.





## Installing Locking Brackets on Whisper Lift II TV Lift – cont.

3. Place the larger end of the locking bracket into the slots in the TV mounting bracket just below the bottom cross bracket on the lift, as shown in the diagram below.



4. With a Philips-head screwdriver, tighten the screw so that the screw is tight against the cross bracket, as shown in the picture below.

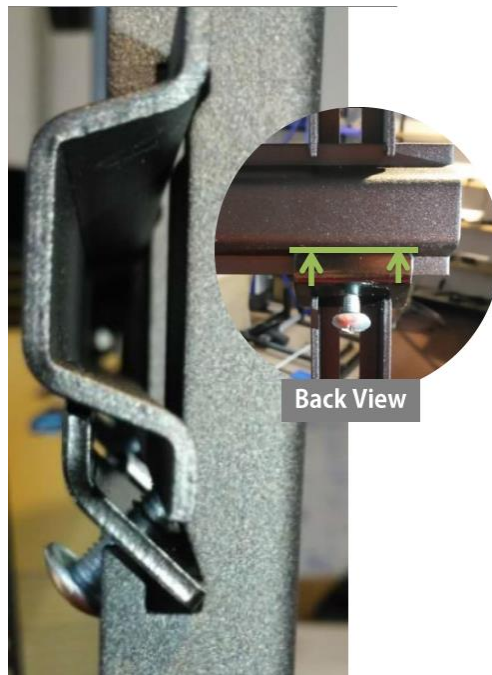

5. After installing the first locking bracket, install the 2nd locking bracket on the other TV bracket in the same manner. Your TV should now be locked in place and not move from side to side



## Setting Adjustable Roller Height

Each Whisper Lift XL PRO comes with an adjustable roller assembly that allows you to set the maximum height of the lift.

**\*\*NOTES:**

1. Top of the TV SHOULD NOT be mounted above the roller on the lift.
2. The roller on the top of the lift should not be raised above the top of the cabinet.

***Tools Needed:***

- none

***Instructions:***

1. Raise the lift to a height that is comfortable for you to work at.
2. The adjustable roller is held in place by 2 screws and wing nuts on either side of the lift. By hand, remove the 4 sets of screws and wing nuts.

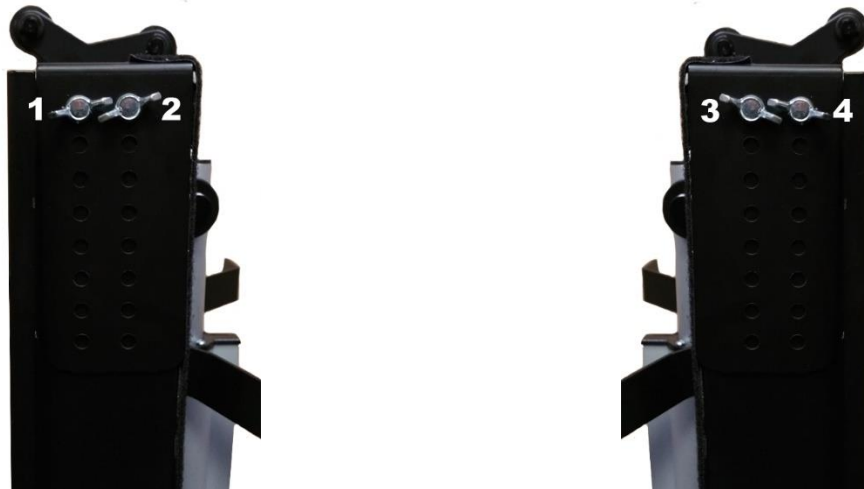

3. Raise the adjustable roller to the desired level and refasten the adjustable roller to the lift using the screws/nuts removed in step 2.

4. Adjust height of adjustable roller as needed so that lid of cabinet closes flush.

## Whisper Lift XL PRO Advanced TV Lift Features

### Initialize the Whisper Lift XL PRO Lift

**PLEASE RUN INTILIZATION PROCEDURE BEFORE OPERATING LIFT AFTER INSTALLATION!**

Before you run the Whisper Lift XL PRO Lift, you will need to initialize the Control box. To initialize the control box, you will need to do the following:

1. Press and HOLD the UP and DOWN button on the wired remote control together at the same time until the red light on the top of the control box starts to flash.

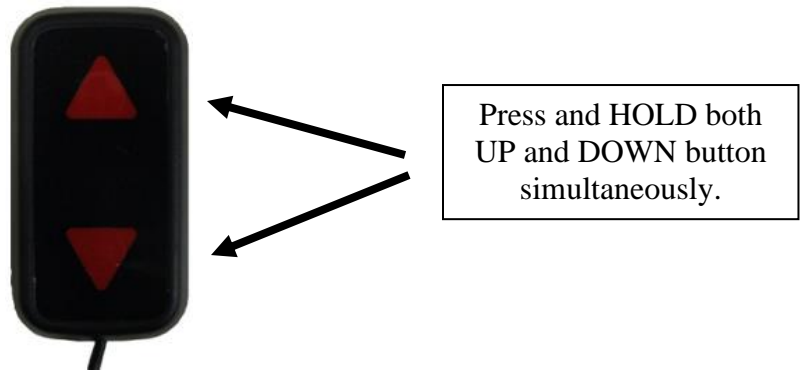

2. Release the UP and DOWN button and the indicator light on the top of the control box will flash 3 times and turn off. The lift will go all the way to the bottom, back up the top and all the way down to the bottom again. The red light on the control box will come back on when the initialization procedure is complete.

*\*\*Note: Do not proceed until this procedure is complete.*

***\*\*DO NOT INSTALL COMPONENTS IN CABINETS OR UNDER TV UNTIL AFTER RUNNING THE LIFT INITIALIZATION PROCESS.***

The initialization process is now complete and you can now use your Whisper Lift XL PRO!

## Whisper Lift XL PRO Advanced TV Lift Features - cont

### Pairing Universal IR Remote with Whisper Lift XL PRO Advanced

The Whisper Lift XL PRO Advanced TV Lift can be paired with your existing universal IR remote control. To pair a universal IR Remote control with the Whisper Lift XL PRO Advanced TV Lift, please follow the directions below:



1. Press and hold the learning button on the control box until the red indicator light starts to flash. The light will flash 3 times and turn off. When the light turns off, the control box is now in pairing mode.
2. Pair the UP/DOWN/STOP to a button on your IR remote. Do the following for each button:
  - a. Press the UP button on the white wireless remote. The red light on the control box will flash once and turn ON.
  - b. Point and aim your IR remote at the IR sensor and press any button on the IR remote to pair the UP function to that button. The red indicator light will flash again and stay ON.
  - c. Follow steps A and B for both the DOWN and STOP buttons.
3. Once pairing is completed, press and hold the learning button on the control box starts to flash. The red indicator light will flash 5 times and light will stay solid once pairing is complete.

You will now be able to operate the Whisper Lift XL PRO Advanced TV Lift with your IR remote control.

**\*\*DISCLAIMER:** Not all IR remotes will pair to the Whisper Lift XL PRO. Some IR remotes (ie. Comcast, Verizon, DirectTV) have programming in their remotes that do not allow all buttons to be paired. We suggest using a universal remote or TV remote to pair with the Whisper Lift XL PRO TV Lift.

## Whisper Lift XL PRO Advanced TV Lift Features - cont

### Setting Lift Height

The Whisper Lift XL PRO Lift has the ability to save a preset lift height. To set the lift height, you will need to do the following:

1. Press and HOLD the UP and DOWN button on the wired remote control together at the same time until the red light on the top of the control box starts to flash.

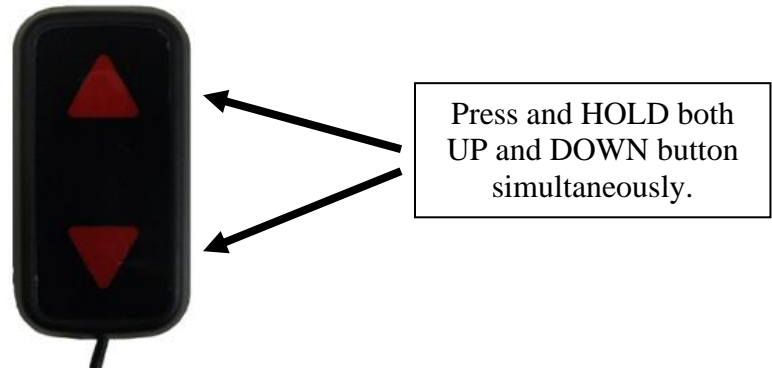

2. Release the UP and DOWN button and the indicator light on the top of the control box will flash 3 times and turn off. The lift will go all the way to the bottom and then start to go back up.

3. Once the lift raises to the desired height, press the UP button on the wired remote to STOP the lift. The lift will then pause and lower to the bottom.

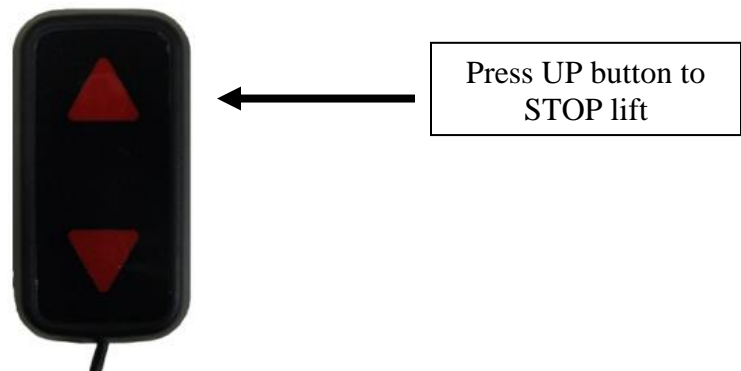

The MAX height on your Whisper Lift XL PRO lift will now be set. To go to the set height, press UP button on either the wired or wireless remote control.

### Setting Lift Height Memory Button (Middle Button) on Wireless Remote

You can use the middle button on the wireless remote to set the lift to any height. Move the lift to the desired height and stop the lift. Press and HOLD the middle button on the wireless remote until the light on the control box starts to flash. Release the middle button and the lights on the remote will flash and turn off. The middle button is now set to move the lift to the desired height.

## Optional Accessories

### Assembling Component Shelf (optional)

**Tools Needed:**

- adjustable wrench
- size 5 metric hex wrench

**Component Shelf Parts**

- 1 Component Shelf
- 2 Shelf Brackets
- 4 Shelf Bracket Spacers
- 4 Shelf Bracket Bolts and Nuts (lift side)
- 2 Hex-Head Shelf Bracket Bolts and Washers (shelf side)



**A. Components Shelf**

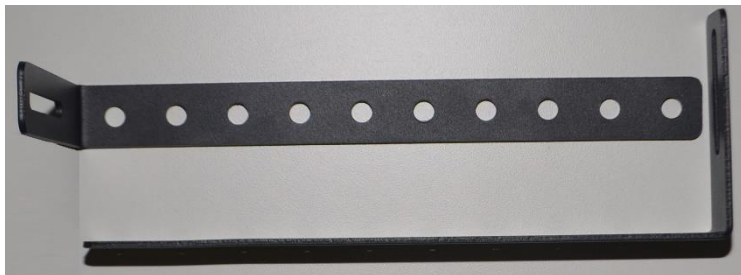

**B. 2 Shelf Brackets**



**C. 2 Hex-Head Shelf Bracket Bolts and Washers (shelf side)**

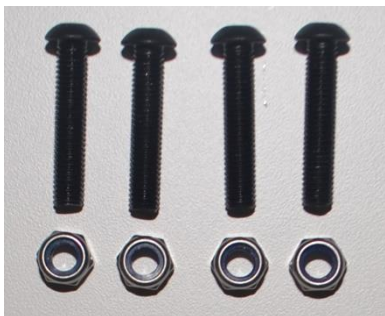

**D. 4 Shelf Bracket Bolts and 4 Nuts (lift side)**



**E. 4 Shelf Bracket Spacers**

## *Assembly Instructions:*

1. After unpacking the shelf parts, attach the 2 shelf brackets (C) to the shelf (A) using the 2 Hex-Head Shelf Bracket Bolts and Washers (B). You will need the parts listed below.



**A. Components Shelf and Parts**

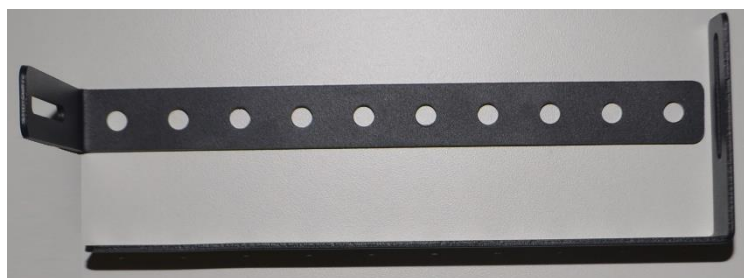

**B. 2 Shelf Brackets**



**C. 2 Hex-Head Shelf Bracket Bolts and Washers (shelf side)**



## Assembling Component Shelf – cont

2. Line up the shorter end of each shelf bracket up (the side with the elongated hole) with the holes the base of the component shelf.

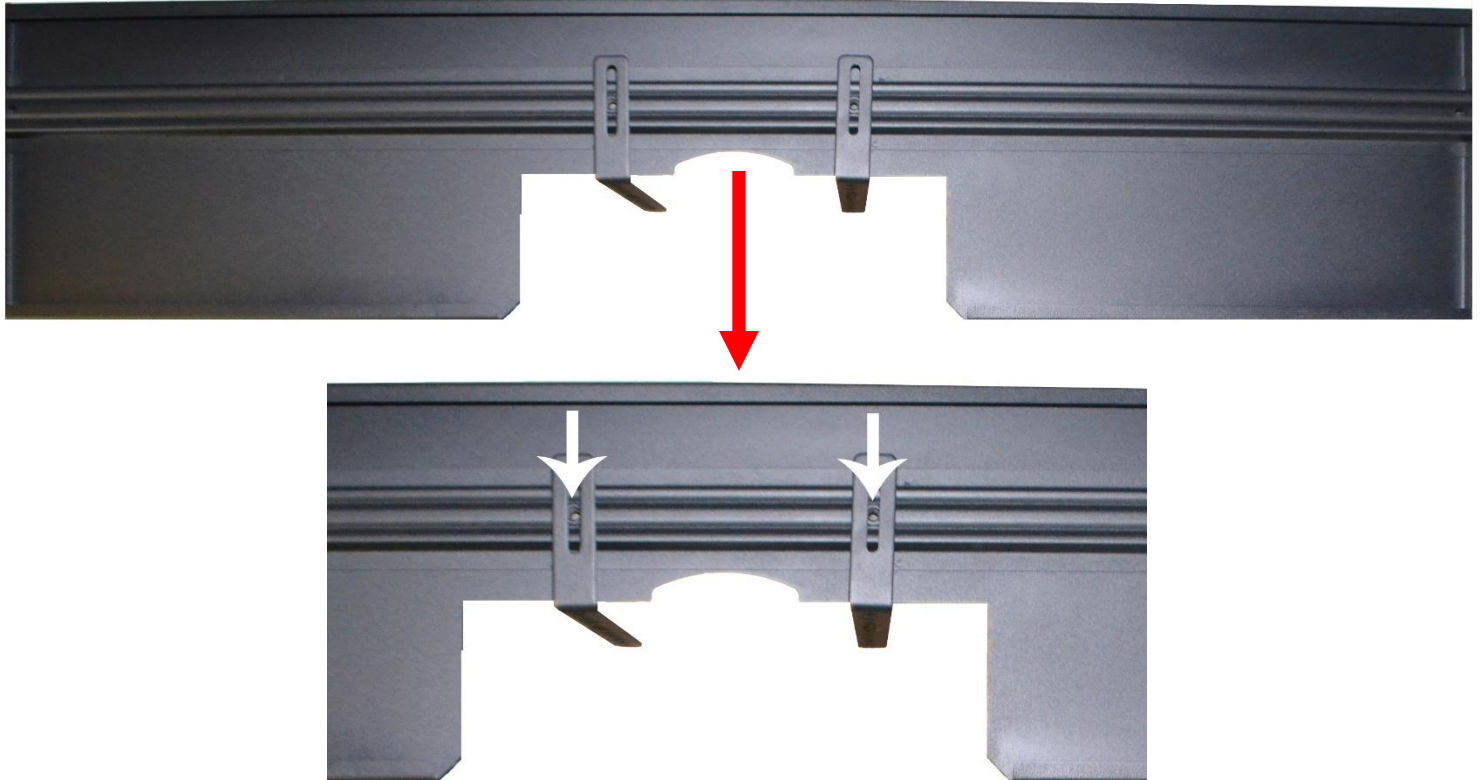

**Elongated holes in shelf bracket lined up with holes in bottom of lift.**

3. Using the 2 Hex-Head Screws and washers, fasten each shelf bracket to the component shelf and tighten bolts.

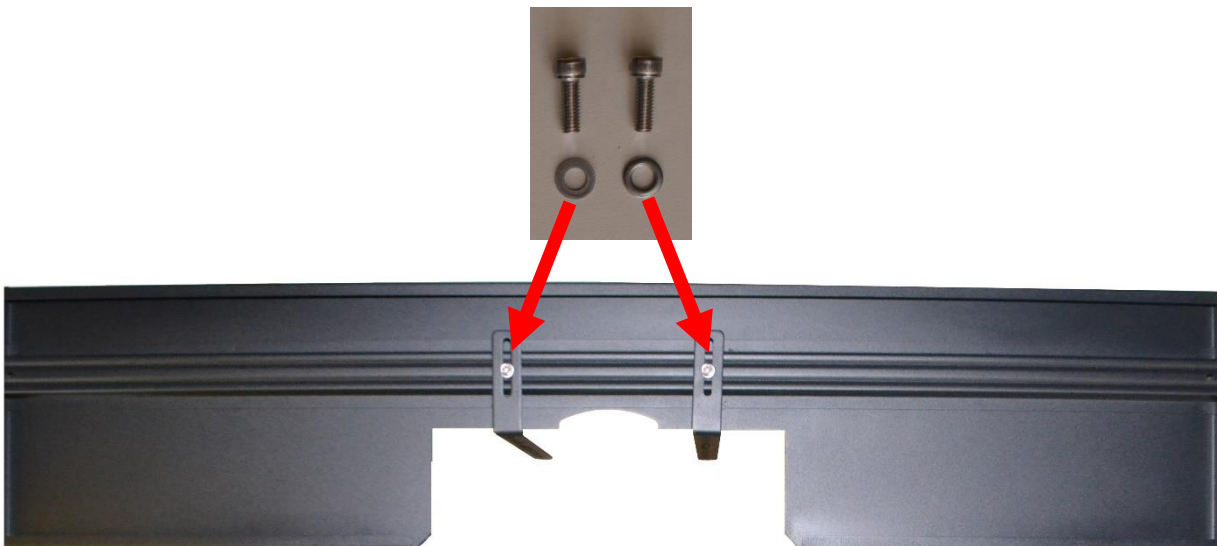

## Assembling Component Shelf – cont

4. Once the shelf is assembled, attach the shelf to the lift. Line the vertical holes in the shelf brackets up with the vertical holes in the lift. Once aligned, install spacer in 2<sup>nd</sup> hole down from the top of the bracket, as shown below.

**\*\*NOTE: DO NOT INSTALL** the spacers when installing the component shelf in Touchstone Home Products Elevate Model TV Lift Cabinets (model #: 72006, 72008, 72009, 72011, 72012, 72013, 72106)

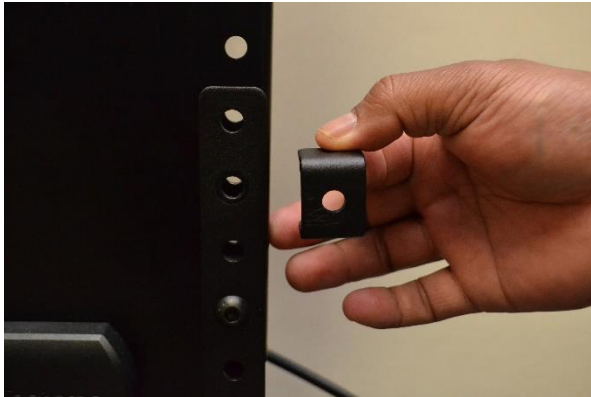

5. Once the spacer is lined up, install the nut and bolt to tighten the spacer to the lift. Use a size 5 metric hex head wrench and adjustable pliers to tighten the nut and bolts.



Thread bolt through bracket and spacer

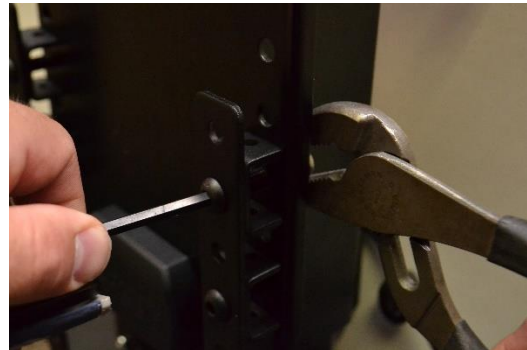

Tighten bolt and nut

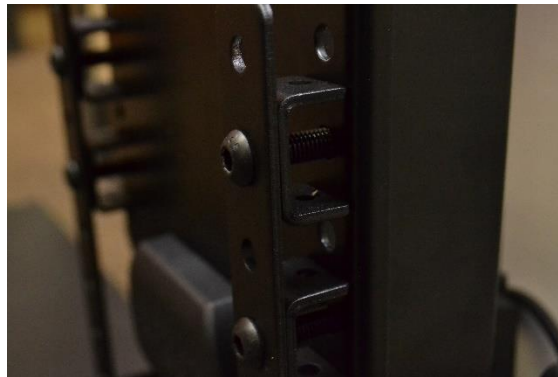

Spacer installed

## Assembling Component Shelf – cont

6. Install all 4 spacers to attach the shelf to the lift. Once installed, the shelf is ready for use.



**Shelf brackets installed.**



## Assembling Component Shelf – cont

7. Install all 4 spacers to attach the shelf to the lift. Once installed, the shelf is ready for use.



**Shelf brackets installed.**

## IR Repeater Kit (optional)

The Touchstone Infrared Repeater allows the customer to install a small satellite TV/cable box in the bottom of the cabinet. The Touchstone Infrared Repeater allows the you to change the channel on their box without having direct line of sight to the component.

For more information on the Touchstone Infrared Repeater Kit, please visit

<http://www.touchstonehomeproducts.com/irrepeaterkit.html> or call our Customer Service Department at 1-800-215-1990 for more information and pricing.

## Technical Support

Should you have any problems with your Touchstone Home Products Whisper Lift XL PRO Advanced TV Lift, our technical support staff is here to help. Our technical support reps are available for phone assistance at 1-800-215-1990 Monday to Friday, from 8:00am to 5:00pm EST. We also can be reached via email at

[support@touchstonehomeproducts.com](mailto:support@touchstonehomeproducts.com)

## Warranty

Touchstone Home Products warrants the Whisper Lift XL PRO Advanced TV Lift to be free from defects in material and workmanship for five years from date of purchase. The warranty includes all parts, motorized components, electronics, and metal. If the Whisper Lift XL PRO Advanced TV Lift proves to be defective in material or workmanship during the warranty period, Touchstone Home Products will replace the defective part free of charge. The replacement part will then be covered by the balance of the time remaining on the customer's original warranty.

Touchstone Home Products' warranty does NOT cover: any product on which the serial number has been defaced, modified or removed; damage, deterioration or malfunction resulting from accident, misuse, neglect, power surges, fire, water, lighting, or other acts of nature, unauthorized product modification, failure to follow instructions supplied with the product, repair or attempted repair by anyone not authorized by Touchstone Home Products, causes external to the product such as electric power fluctuations or failure, use of supplies or parts not meeting Touchstone Home Products specifications, or any other cause which does not relate to a product defect.

 **CALL US FIRST!**   
**DO NOT RETURN TO STORE.**

For immediate help with assembly, product information,  
or if your product arrives damaged, call our toll-free number at

**800-215-1990**

or email:

[customerservice@thpus.com](mailto:customerservice@thpus.com)

**Our staff is ready to provide assistance.**